

# JENSEN®

## DOCKING DIGITAL MUSIC SYSTEM WITH CD FOR iPod®



## OWNER'S MANUAL JiMS-210

(iPod® Not Included)

PLEASE READ THIS OPERATING MANUAL COMPLETELY BEFORE OPERATING  
THIS UNIT AND RETAIN THIS BOOKLET FOR FUTURE REFERENCE



# TABLE OF CONTENTS

DEAR JENSEN® CUSTOMER .....	2
IMPORTANT SAFETY INSTRUCTIONS .....	2
COMPLIANCE WITH FCC REGULATIONS .....	4
PRODUCT FEATURES .....	5
INSTALLATION .....	5
LOCATION OF CONTROLS .....	6
RADIO OPERATIONS .....	8
iPod DOCKING .....	8
CD OPERATIONS .....	9
DISPLAY MESSAGE AT CD MODE .....	11
AUXILIARY INPUT .....	11
CLOCK SETTING .....	12
ALARM OPERATIONS .....	12
SLEEP TIMER .....	13
CARE AND MAINTENANCE .....	14
TROUBLESHOOTING GUIDE .....	15
SPECIFICATIONS .....	16
SERVICE .....	16

"Made for iPod" means that an electronic accessory has been designed to connect specifically to iPod and has been certified by the developer to meet Apple performance standards.

Apple is not responsible for the operation of this device or its compliance with safety and regulatory standards.

iPod is a trademark of Apple Inc., registered in the U.S. and other countries.

## DEAR JENSEN® CUSTOMER

Selecting fine audio equipment such as the unit you've just purchased is only the start of your musical enjoyment. Now it's time to consider how you can maximize the fun and excitement your equipment offers. This manufacturer and the Electronic Industries Association's Consumer Electronics Group want you to get the most out of your equipment by playing it at a safe level. One that lets the sound come through loud and clear without annoying blaring or distortion and, most importantly, without affecting your sensitive hearing. Sound can be deceiving. Over time your hearing "comfort level" adapts to higher volumes of sound. So what sounds "normal" can actually be loud and harmful to your hearing. Guard against this by setting your equipment at a safe level BEFORE your hearing adapts.

### To establish a safe level:

- Start your volume control at a low setting.
- Slowly increase the sound until you can hear it comfortably and clearly, and without distortion.

### Once you have established a comfortable sound level:

- Set the dial and leave it there.

Taking a minute to do this now will help to prevent hearing damage or loss in the future. After all, we want you listening for a lifetime.

### We Want You Listening For a Lifetime

Used wisely, your new sound equipment will provide a lifetime of fun and enjoyment. Since hearing damage from loud noise is often undetectable until it is too late, this manufacturer and the Electronic Industries Association's Consumer Electronics Group recommend you avoid prolonged exposure to excessive noise.

### Customer's Record:

The serial number of this product is found on its bottom cover. You should note the serial number of this unit in the space provided as a permanent record of your purchase to aid in identification in the event of theft or loss.

**Model Number:** JiMS-210

**Serial Number:** \_\_\_\_\_

## IMPORTANT SAFETY INSTRUCTIONS

When used in the directed manner, this unit has been designed and manufactured to ensure your personal safety. However, improper use can result in potential electrical shock or fire hazards. Please read all safety and operating instructions carefully before installation and use, and keep these instructions handy for future reference. Take special note of all warnings listed in these instructions and on the unit.

### 1. Water and Moisture

The unit should not be used near water. For example: near a bathtub, washbowl, kitchen sink, laundry tub, swimming pool or in a set basement.

### 2. Ventilation

The unit should be situated so that its location or position does not interfere with its proper ventilation. For example, it should not be situated on a bed, sofa, rug or similar surface that may block the ventilation openings. Also, it should not be placed in a built-in installation, such as a bookcase or cabinet, which may impede the flow of air through the ventilation openings.

### 3. Heat

The unit should be situated away from heat sources such as radiators, heat registers, stoves or other appliances (including amplifiers) that produce heat.

### 4. Power Source

The unit should be connected to a power supply only of the type described in the operating instructions or as marked on the appliance.

# IMPORTANT SAFETY INSTRUCTIONS

## 5. Power Cord Protection

Power supply cords should be routed so that they are not likely to be walked on or pinched by items placed upon or against them. It is always best to have a clear area from where the cord exits the unit to where it is plugged into an AC outlet.

## 6. Cleaning

The unit should be cleaned only as recommended. See the section "Care and Maintenance" of this manual for cleaning instructions.

## 7. Object and Liquid Entry

Care should be taken so that objects do not fall and liquids are not spilled into any openings or vents located on the product.

## 8. Attachments

Do not use attachments not recommended by the product manufacturer.

## 9. Lightning and Power Surge Protection

Unplug the unit from the wall outlet and disconnect the periods of time. This will prevent damage to the product due to lightning and power-line surges.

## 10. Overloading

Do not overload wall outlets, extension cords, or integral convenience receptacles as this can result in a risk of fire or electric shock.

## 11. Damage Requiring Service

This unit should be serviced by qualified service personnel when:

- A. The power supply cord or plug has been damaged.
- B. Objects have fallen into or liquid has been spilled into the enclosure.
- C. The unit has been exposed to rain.
- D. The unit has been dropped or the enclosure damaged.
- E. The unit exhibits a marked change in performance or does not operate normally.

## 12. Antenna

Do not connect an external antenna to the unit (other than that provided).

## 13. Periods of Nonuse

If the unit is to be left unused for an extended period of time, such as a month or longer, the power cord should be unplugged from the unit to prevent damage or corrosion.

## 14. Servicing

The user should not attempt to service the unit beyond those methods described in the user's operating instructions. Service methods not covered in the operating instructions should be referred to qualified service personnel.

### CLASS 1 LASER PRODUCT

CLASS 1 LASER PRODUCT  
APPAREIL LASER DE CLASSE 1  
PRODUCTO LASER DE CLASE 1

CAUTION  
INVISIBLE LASER RADIATION  
WHEN OPEN AND INTERLOCKS  
DEFEATED  
AVOID EXPOSURE TO BEAM.



**This product contains a low power laser device.**

**NOTE:** This product complies with DHHS Rule 21 Subchapter J at date of manufacture.

Follow the advice below for safe and appropriate operations.

## IMPORTANT SAFETY INSTRUCTIONS

### ON PROTECTION AGAINST LASER ENERGY EXPOSURE

- As the laser beam used in this compact disc player is harmful to the eyes, do not attempt to disassemble the casing.
- Stop operation immediately if any liquid or solid object should fall into the cabinet.
- Do not touch the lens or poke at it. If you do, you may damage the lens and the player may not operate properly.
- Do not put anything in the safety slot. If you do, the laser diode will be ON when the CD door is still open.
- This unit employs a laser. The use of controls or adjustment or performance of procedures other than those specified here may result in exposure to hazardous radiation.

## COMPLIANCE WITH FCC REGULATIONS

This device complies with Part 15 of the FCC Rules. Operation is subject to the following two conditions: (1) This device may not cause harmful interference, and (2) this device must accept any interference received, including interference that may cause undesired operation.

In accordance with FCC requirements, changes or modifications to this unit not expressly approved by the party responsible for compliance could void the user's authority to operate the equipment.

### NOTE:

This equipment has been tested and found to comply with the limits for a Class B Digital Device, pursuant to Part 15 of the FCC Rules. These limits are designed to provide reasonable protection against harmful interference in a residential installation. This equipment generates, uses and can radiate radio frequency energy and, if not installed and used in accordance with the instructions, may cause harmful interference to radio communications. However, there is no guarantee that interference will not occur in a particular installation. If this equipment does cause harmful interference to radio or television reception, which can be determined by turning the equipment off and on, the user is encouraged to try to correct the interference by one or more of the following measures:

- Reorient or relocate the receiving antenna.
- Increase the separation between the equipment and receiver.
- Connect the equipment into an outlet on a circuit different from that to which the receiver is connected.
- Consult the dealer or an experienced radio/TV technician for assistance.

### CAUTION:

**Changes or modifications not expressly approved by the party responsible for compliance could void the user's authority to operate the equipment.**

## PRODUCT FEATURES

JiMS-210 is an iPod Docking Music System which incorporates the following features :

iPod, iPod mini, iPod classic, iPod touch and iPod nano Player/Re-charger

A CD player playback music with Audio CD / MP3 format

AM / FM Stereo receiver with digital read out on LCD

Audio line-in for connecting other digital audio player

Clock and Alarm timer function

- Wake up to Alarm (Buzzer), iPod, CD or Radio with Snooze function
- Sleep timer function
- Built-in 2 High Fidelity Speakers
- LCD display with selectable Off / Dim / Bright Back-lit
- Attached FM Antenna wire for better radio reception
- Stereo Headphone jack connection for private listening

## INSTALLATION

### Clock setting battery back-up

The battery back-up compartment is located on the bottom of the unit.

- (1) Remove the battery compartment door.
- (2) Follow the polarity diagram shown inside the compartment and install 3 x AAA batteries (not included).
- (3) Replace the battery compartment door.

### **WARNING:**

- Be sure that the batteries are installed correctly. Wrong polarity may damage the unit.
- Do not mix old and new batteries.
- Do not mix alkaline, standard (carbon-zinc) or rechargeable (nickel-cadmium) batteries.
- Only batteries of the same or equivalent type as recommend are to be used.
- If the unit is not to be used for an extended period of time, remove the battery.
- Do not dispose of batteries in fire, batteries may explode or leak.

### AC-DC Adaptor Connection

The unit is powered by an external AC-DC Power Adaptor with an output of 10V DC / 1000mA (included).

- (1) Plug the adaptor into an outlet rated at 120V AC / 60Hz.
- (2) Insert the adaptor's DC output plug into the DC-IN jack on the back of the unit.

**NOTE:** This unit is not magnetically shielded and may cause color distortion on the screen of some TVs or video monitors. To avoid this, you may need to move the unit further away from the TV or monitor if unnatural color shifts or image distortion occurs.

# LOCATION OF CONTROLS

## Main Unit

Top view

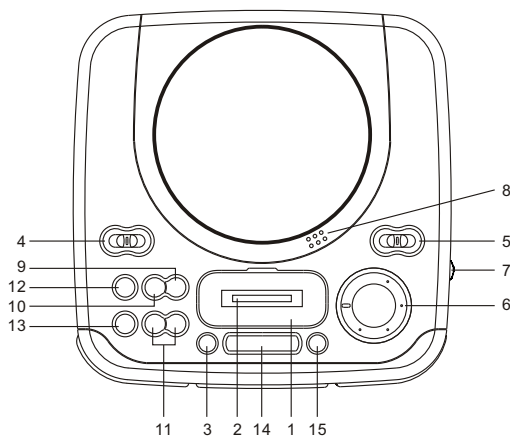

Front view

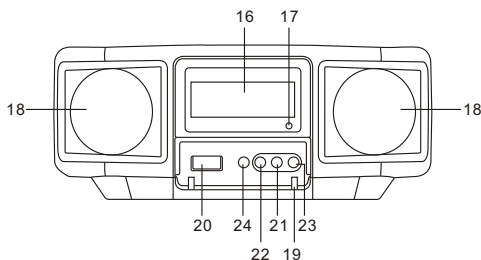

Rear view

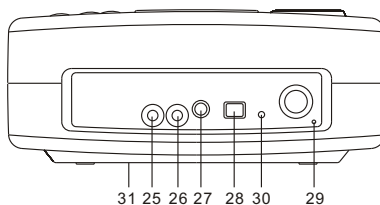

1. **iPod docking station**
2. **iPod docking connector**
3. **POWER On/Off** button ----- Turns the unit on or off
4. **Function switch** ----- Select RADIO / iPOD / CD / AUX modes.
5. **Band switch** ----- Select between FM STEREO / FM (mono) / AM radio bands.
6. **TUNING knob** ----- Adjusts the radio channel frequency up or down.
7. **VOLUME wheel** ----- Adjusts the volume level up or down.
8. **Push Open** **CD Cover Location** ----- Press here to open / close the CD Cover.
9. **PLAY / PAUSE** button ----- iPod or CD Play / Pause
10. **CD STOP** button ----- Stop CD Playback.
11. **▶▶ / ◀◀** button ----- In CD or iPod mode, skip tracks Forward / Backward or perform high-speed search.  
In Clock setting mode, used to adjust Hour / Minute display.
12. **PGM** button ----- Set CD program.
13. **ALARM** button ----- Turn the alarm on and off ; Set alarm time.
14. **SNOOZE** button ----- Activate the snooze function.
15. **SLEEP** button ----- Select the time duration of the sleep timer.
16. **LCD display**
17. **Remote Infrared Sensor**
18. **Pair of Speakers**
19. **Front Control Cover**
20. **ALARM SOUND** switch ----- Alarm source Buzzer / AUTO (Radio / iPod / CD) selection
21. **P-MODE** button ----- Select play-mode in CD mode.
22. **+10** button ----- To advance 10 songs (files) in CD mode
23. **DIR+** button ----- Advance to next directory when play MP3 CD.
24. **CLK SET / DIS/CLK** button ----- In CD and Radio modes, display clock time.  
In power "off" mode, for clock setting



- 25. **AUX IN** jack : Auxiliary audio signal input
- 26. **Headphone Jack**
- 27. **DC-in** jack : For the connection of external DC powersupply
- 28. **BACKLIGHT** switch ----- Select Back-lit Off/ Dim /Bright.
- 29. **FM Antenna wire**
- 30. **RESET** button ----- For resetting the unit.
- 31. **Battery Compartment** -----located at bottom of the unit.

## LOCATION OF CONTROLS

### Remote Control

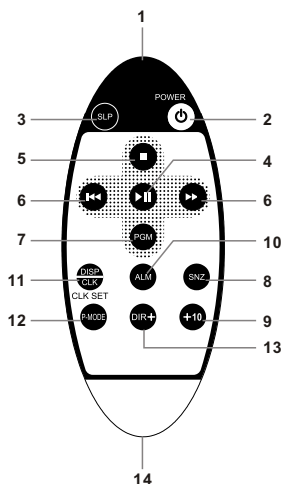

- 1. **Infra-red Transmitter**
- 2. **POWER On/Off** button
- 3. **SLEEP** button
- 4. **iPod / CD PLAY / PAUSE** button
- 5. **CD STOP** button
- 6. **▶▶/◀◀** button ----- In CD or iPod mode, skip tracks Forward / Backward or perform high-speed search.
- 7. **PGM** button ----- Set CD program.
- 8. **SNOOZE** button
- 9. **+10** button ----- To advance 10 songs (files) in CD mode
- 10. **ALARM** button ----- Turn the alarm on an off ; Set alarm time.
- 11. **DISP/CLK** button ----- In CD and Radiomodes, display clock time.  
In power "off" mode, for clock setting
- 12. **P-MODE** button ----- Select play-mode in CD mode.
- 13. **DIR+** button ----- Advance to next directory (folder) in CD mode.
- 14. **Battery Compartment**

# RADIO OPERATIONS

## **FM Antenna**

Unwrap and fully extend the FM Antenna wire for best FM radio reception.

## **Radio Tuning**

1. Press the **POWER On/Off**  button to turn on the unit.
2. Slide the **FUNCTION (#4)** switch to select Radio mode.
3. Slide the **BAND (#5)** switch to select AM or FM radioband.
4. Rotate the **TUNING (#6)** knob and tune to a desired radio station.
5. Adjust the sound level by turning the **VOLUME (#7)** wheel.

**NOTE: The iPod may cause interference to the AM reception if it is docked and turned ON. You should turn off the iPod manually or remove it from the dock to improve AM reception.**

## **Tips for the Best Reception**

To obtain the best AM reception, slightly rotate the unit until the clearest signal is received or place it near outdoor.



To obtain the best FM reception, fully extend the FM Antenna and adjust its direction.

# iPod DOCKING

If the docking port will not be used for an extended period of time, it is recommended to cover the docking port by using the "Dock Cover" insert (included).

1. Use the iPod adaptor included in your iPod and insert it into the docking area. Your iPod can now be inserted into the docking port by placing the connector on the bottom of the iPod onto the connector in the docking bay.

**Note:** - Please be careful when seating the iPod into the docking to avoid damaging the 30-pin connector on the iPod or in the docking system.

2. Press the **POWER On/Off**  button to turn on the unit.
3. Slide the **FUNCTION** switch to select iPod mode. The iPod will start playing automatically and start charging immediately.
4. Press the **PLAY / PAUSE**  button to pause or resume iPod playback.
5. Adjust the sound level by turning the **VOLUME** wheel (#7).





**Note :** *The volume level cannot be adjusted using the volume control on your iPod after being docked.*

6. The iPod charges even during playback.

**Note :** *The iPod will only charge in iPod or AUX modes.*

7. To remove the iPod from the unit, press and hold the **PLAY/PAUSE** button for three seconds to switch off the device and then gently remove it from the docking connector.



## **iPod playback control:**

- Press the **PLAY/PAUSE**  button to pause or resume the iPod playback;
- Press the iPod Skip/Search Forward  or Backward  button to skip to the next or previous song;
- Press and hold the iPod Skip/Search Forward  or Backward  button for fast-forwarding or fast-rewinding during playback.

# CD OPERATIONS

The CD player supports CD/CD-R / CD-RW discs recorded either Audio CD or MP3 file format.

## CD Playback

1. With the unit power is OFF, press the **Push Open**  located on the CD Cover to open the compartment.
2. Place a CD onto spindle with printed side facing up.
3. Close the CD cover.
4. Press the **POWER On/Off**  button to turn on the unit.
5. Slide the **FUNCTION** switch to select CD mode.
6. Press the **PLAY/ PAUSE**  button to start playback CD music.

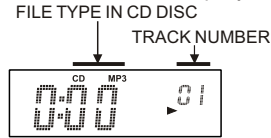

PLAYBACK TIME





7. Adjust the volume level by turning the **VOLUME** wheel.
8. (a) To skip to a desired CD track, press the **▶▶ / ◀◀** button.  
For MP3 disc: press **DIR+** button to select different directories (folders).



FOLDER (DIRECTORY) NUMBER  
to advance 10 songs (files) , press the **+10** button.



PLAYBACK TIME

- (b) To fast-forward or fastrewind within the track playing, press and hold the **▶▶ / ◀◀** button.
- (c) To pause CD playback, press the **PLAY/PAUSE**  button;  
The playtime counter stops and flashes.  
To resume CD playback, press the **PLAY/PAUSE**  button again.
9. To stop CD playback, press the **CD STOP**  button.  
Total number of tracks and total playtime are shown.
10. To turn the unit off, press the **POWER On/Off**  button .

## CD Play Modes

During the CD playback, you may select different play mode by pressing the **P-MODE** button.

- (a) To repeat playback of one track, press **P-MODE** button once.

A "repeat one" indicator  appears on LCD.

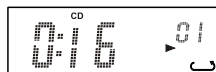

- (b) To repeat playback of an entire CD, press **P-MODE** button twice.

A "repeat all" indicator  appears on LCD.



- (c) To playback CD tracks in random order, press **P-MODE** button three times.  
"RAN" indicator appears on LCD.



- (d) Toplayback and repeat all CD tracks in random order, press **P-MODE** button four times.  
"RAN" and **CALL** indicators appears on LCD.



**NOTE:** If CD STOP ■ pressed, the CD play mode will be cancelled.

### CD Program Playback

This feature allows you to program up to 10 tracks (files) to play in a desired order.

1. With CD playback stopped, press the **PGM** button once.  
"01" (track number), P-01 (program number) indicators display on LCD and a "PROG" indicator appears and flashing.

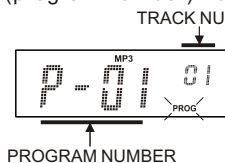

2. During the time, press the **▶▶** or **◀◀** button to select a track number as desired programming track.  
You may press **+10** button to advance 10 tracks then press the **▶▶** button for higher track number, if necessary.



3. When desired track number is displayed, press the **PGM** button to confirm entries.  
Program number will advance by one and the "PROG" indicator keeps flashing, the track number becomes "- -".



4. To program up to the desired number of tracks, repeat steps 2 and 3 until all desired tracks are entered.  
5. To begin programmed playback, press the **PLAY / PAUSE ▶/||** button.  
The "PROG" indicator stops flashing and the CD starts programmed playback.

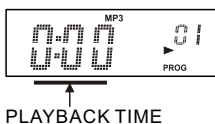





6. To cancel programmed playback, press the CD STOP ■ button once with CD playback stopped.

### Notes :

- If you press the **▶▶** button during programmed playback, the unit will skip forward to the next track in the program.
- The CD play mode function, **↶** repeat one track and **↷** repeat all programmed tracks work in the same manner as during normal CD playback (see CD Play Modes above).
- Random and RandomAll CD play mode functions are disabled in program play.

## DISPLAY MESSAGE AT CD MODE

Multi-Function Display	Meaning
	CD door opened
	Reading inserted CD
	No Disc
	Inserted Disc cannot be recognized

**NOTE:** If the disc is dirty, damaged or unreadable, the “DISC” or “Err” will appear in the display. If this occurs, clean the disc, insert the disc correctly or try another disc.

### Notes on CD-R/RW Discs

1. Because of non-standardized format definition/production of CD-R/RW/MP3-CD, playback quality and performance are not guaranteed.
2. Manufacturer is not responsible for playability of CD-R/RW/MP3-CD due to recording conditions such as PC performance, writing software, media ability, etc.
3. Do not attach a label or seal to either side of CD-R/RW/MP3-CD disc. It may cause a malfunction.

## AUXILIARY INPUT

This unit provides an auxiliary audio signal input for connecting external audio devices.

Use the included audio cable with 3.5 mm stereo plug to connect the external device to the AUX IN Jack located on the back of the unit.

Connect the other end of the cable to a Line Out Jack or Headphone Jack of your non-dockable MP3 player, CD player and older, non-dockable iPods then listen to your external source through the speakers of this system.

1. Connect the audio cable (included) with 3.5 mm stereo plug to the **AUX IN Jack** located at rear of the unit.
2. Connect the other end of the cable to a Line Out Jack or Headphone Jack of your external audio device.
3. Turn on the external audio device.
4. To select auxiliary audio input, slide the **FUNCTION** switch to AUX mode position.
5. The volume level can now be controlled through the main unit. Operate all other functions on the auxiliary device as usual.

### Note:

- (1) If you connected the Line Out Jack of your external device then you only need to adjust the volume control of this unit. If you connected the Headphone Jack of your external device then you may need to adjust both the volume control of your external device and the volume control of this unit to find the most desirable volume setting.
- (2) Press the **POWER ON/OFF**  button turning off the unit when you finish listening. Don't forget to switch off the power of your external device as well.

# CLOCK SETTING

## Setting Clock Time



The clock can be set in Power Off mode.

1. Press and hold the **CLK SET** button until the "minute" digits flashes on display.
2. Press the **▶▶ / ◀◀** button to set the minute.
3. Press the **CLK SET** button again, the "hour" digits flashes on display.
4. Press the **▶▶ / ◀◀** button to set the hour.
5. Press the **CLK SET** button to confirm the settings.

# ALARM OPERATIONS

## Setting Alarm Time

When the unit is in Power Off mode :

1. Press the **ALARM** button once or the alarm indicator  appears on display.
2. Press and hold the **ALARM** button until the alarm "minute" digits flashes on display.  
The alarm indicator  flashes as well.
3. Press the **▶▶ / ◀◀** button to set the minute.
4. Press the **ALARM** button again, the "hour" digits flashes on display.
5. Press the **▶▶ / ◀◀** button to set the hour.
6. Press the **ALARM** button to confirm entries and enable the alarm function then exit alarm setting mode, the alarm indicator  stays on.

To disable ALARM function, press **ALARM** button ; the alarm indicator  turns off from LCD.

To enable ALARM function, press **ALARM** button again ; the alarm indicator  turns on from LCD.

## Selecting Alarm Sound Source

- (a) To select wake to Alarm (Buzzer); slide the **ALARM SOUND** switch to BUZZ position.
- (b) To select wake to radio; slide the **ALARM SOUND** switch to AUTO then slide the **FUNCTION** switch to RADIO position.  
**Note** : Ensuring a desired radio station is tuned and the proper volume level is set.
- (c) To select wake to iPod; slide the **ALARM SOUND** switch to AUTO then slide the **FUNCTION** switch to iPod position.  
**Note** : (1) Ensuring the proper volume level is set.  
(2) When "wake to iPod" is selected but your iPod has not been docked, the alarm source will be redirected to the Buzzer automatically when the alarm time is reached.
- (d) To select wake to CD; slide the **ALARM SOUND** switch to AUTO then slide the **FUNCTION** switch to CD position.  
**Note** : (1) Ensuring the proper volume level is set.  
(2) When "wake to CD" is selected but the CD has not been placed in the CD compartment, the alarm source will be redirected to the Buzzer automatically when the alarm time is reached.
- (e) If the **ALARM SOUND** switch slide to AUTO and the **FUNCTION** switch is set at AUX position; it performs as the "wake to Alarm (Buzzer)" function.

## Wake to Buzzer

- After the alarm is reached, the buzzer alarm will sound immediately for 5 minutes.
- When the alarm sounds, it can be temporarily stopped by pressing the **SNOOZE** button.  
The display will show the indicator "SNOOZE".
- The alarm will be delayed for 6 minutes and then come again.
- This manual snooze operation can be repeated 10 times.

### **Wake to Radio**

- The radio will automatically turn on when the alarm time is reached.
- The radio alarm will keep for 60 minutes and then automatically shut off.
- To stop the radio alarm sound immediately, press the **ALARM** button once.

### **Wake to iPod**

- Your docked iPod will automatically switch on when the alarm time is reached.
- The iPod playback will play for 60 minutes and then automatically shut off.
- To stop the iPod playback immediately, press the **ALARM** button once.

### **Wake to CD**

- The CD will start playback automatically when the alarm time is reached.
- The playback will keep for 60 minutes and then automatically shut off.
- To stop the CD alarm sound immediately, press the **ALARM** button once.

### **Snooze Function**

- You may activate the Snooze function manually after the alarm sounds by pressing the **SNOOZE** button. The display will show the indicator "SNOOZE".
- The alarm will be delayed for 6 minutes and then come again.
- This manual snooze operation can be repeated 10 times.

## **SLEEP TIMER**

The Sleep Timer allows you to set the unit automatically power off after a selected sleep time duration is set.

When the unit is in Power On mode :

- To activate the Sleep Timer and select the sleep time, press the **SLEEP Zz** button repeatedly. The sleep times available for choosing are : 90 to 10 minutes (10 minutes per step or per each key pressing of the **SLEEP Zz** button). The display shows the indicator "SLEEP".
- To switch off the Sleep Timer, press the **SLEEP** button repeatedly until the "SLEEP" indicator disappears on display.
- To switch off the unit before the selected sleep time, press the **POWER On/Off**  button once.
- To check the current sleep time, press the **SLEEP Zz** button once.

### **Note :**

If you are falling asleep to music from an external device connected to the AUX input, the sleep timer will shut off the power to this system but it will not turn off the external device.

## CARE AND MAINTENANCE

- Do not subject the unit to excessive force, shock, dust or extreme temperature.
- Do not tamper the internal components of the unit.
- Clean your unit with a damp (never wet) cloth. Solvent or detergent should never be used.
- Avoid leaving your unit in direct sunlight or in hot, humid or dusty places.
- Keep your unit away from heating appliances and sources of electrical noise such as fluorescent lamps or motors.

If drop-outs or interruptions occur in the music during play, or if the disc fails to play at all, its bottom surface may require cleaning. Before playing, wipe the disc from the center outwards with a good soft cleaning cloth.



### Resetting the Unit

If the unit is subject to a power surge or electric shock, it is possible that the internal micro-controller may lock up and the unit will not respond to any commands from the top panel controls or remote control.

1. In this event, unplug and then reconnect the AC power plug into the wall outlet.
2. Use a straightened paper clip, toothpick or similar objects to press the RESET button located at rear of the main unit (see the below figure). The reset operation clears the system memory and all of your previous settings will be erased. **CAUTION: DO NOT USE SHARP, POINTED OBJECT TO PRESS THE RESET BUTTON. IT MAY DAMAGE THE RESET SWITCH INSIDE THE UNIT.**

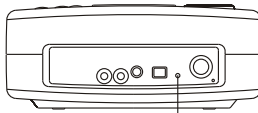

RESET button



## TROUBLESHOOTING GUIDE

Symptom	Possible Problem	Solution
The unit does not respond (no power)	AC Adaptor is not plugged into a wall outlet or the connector is not plugged into the power supply jack on the back of the unit.	Plug the AC adaptor into a wall outlet and plug the connector into the supply jack on the unit.
	Wall outlet is not functioning.	Plug another device into the same outlet to confirm the outlet is working.
iPod® does not dock properly	Using no/wrong iPod® Adaptor.	Make sure the dock insert is the proper fit for your iPod®.
	iPod® does not install properly.	Remove your iPod® from the dock and check for obstruction on the connectors in the dock and on your iPod®. Then reseat it in the dock.
iPod® does not respond to the speaker system	iPod® is not installed properly.	Remove your iPod® from the dock and check for obstruction on the connectors in the dock and on your iPod®. Then reseat it on the dock.
	Your iPod® is locked up.	Please make sure that your iPod® is working properly before docking into the unit. Please refer to your iPod® manual for details.
iPod® does not charge	iPod® is not installed properly.	Remove your iPod® from the dock and check for obstruction on the connectors in the dock and on your iPod®. Then reseat it in the dock.
	iPod® is locked up/ frozen. iPod® battery has problem.	Please make sure your iPod® is working properly before docking into the unit. Please refer to your iPod® manual for details.
	Unit is in Radio or CD mode	Select iPod, AUX or Standby mode for iPod charging
iPod unintentionally wake up in PAUSE mode	It may be caused during function switching	Wait for 3 minutes, iPod will enter sleep mode automatically
Blank iPod video screen in standby mode	It may be caused during function switching	Wait for 3 minutes, iPod will enter sleep mode automatically
AM band is too noisy	The reception at the set location is poor.	Slightly rotate the unit for the best reception.

Symptom	Possible Problem	Solution
Sound is distorted	Volume level is set too high.	Decrease the volume.
	Sound source is distorted.	If the iPod original sound source is of poor quality, distortion and noise are easily noticed with high-power speakers. Try a different audio source such as a music CD.  If you are using an external sound source like older generation of iPod®, try reducing the output volume on the device itself. Also try turning bass boost OFF or change the EQ setting.
CD Player does not play.	CD mode is not selected.	Slide the <b>FUNCTION</b> switch to select CD mode.
	CD is not installed or installed incorrectly	Press the CD onto spindle, printed side facing up.
CD skips while playing.	Disc is dirty or scratched.	Wipe with cloth or use another disc.
Unit gets warm after extended play at high volume	This is normal.	Turn the unit off for a period of time or lower volume.

## SPECIFICATIONS

### Power Requirement

#### Main unit

DC input:

DC10V,1000mA

Battery back up for clock:

3 x DC1.5V 'AAA' (UM-4) Batteries

#### Remote Control

1 x CR2032 Lithium Battery

### Frequency Range

#### Radio

AM520 - 1710kHz

FM88 - 108 MHz

## SERVICE

Please refer to the instructions on the enclosed warranty card for returning your unit for service. When returning the unit, please remove batteries to prevent damage to the unit in transit and/or from possible leakage. We are not responsible for batteries returned with the product or for the cost of replacement.

Distributed by:

SPECTRA Merchandising International, Inc.

Chicago Industry Tech Park

4230 North Normandy Avenue

Chicago, IL 60634, U.S.A.

Please have model number ready, for Customer Service, call 1-800-777-5331.

\*The specification and external appearance of the set are subject to change without prior notice.\*

Printed in China